

LED Commercial Sensor LED DD

12W / 18W GR10q (4-pin) LED DD Lamp



Overview

Kosnic's range of LED DD lamps takes a fresh approach to functional lighting with a design philosophy offering plug-in emergency packs and microwave sensors so that there are no barriers to retrofitting LEDs in commercial fittings. The products bring the energy saving capabilities of LED technology to the commercial environment and the lamps can quickly replace fluorescent DD lamps with little or no rewiring.

Features

- Save energy up to 65% compared with a fluorescent DD lamp with magnetic ballast.
- For maximum energy savings, bypass all control gear and supply directly from the mains.
- Single side high lumen output for light only where it's needed.
- Long life of 30,000h.
- Optional 10% dimming corridor function.
- Compatible with Kosnic emergency modules.
- Instant start.
- Negligible UV output.
- Mercury free.

Microwave Sensor

The LED DD lamp has a built-in microwave motion sensor. The sensor can be adjusted to control the sensor's ambient light level threshold, detection range and illumination time. The latest version includes a dimming corridor function which can be set to keep the lamp on at 10% when not in use.

Emergency Module Compatible

The LED DD lamp is compatible with the Kosnic emergency modules, which provides power in the event of a cut in the supply and must be wired to the un-switched supply through the un-switched Live terminal. The battery will supply the lamp for over 3 hours at a reduced output.

Safety and Maintenance

- Switch off supply before installing or removing lamp. Allow to cool before handling.
- Do not dispose of in household waste.
- Dispose of in appropriate section of local civic amenity site or recycling centre.

Specifications

Product Code	DD12CRD/4P-SCT	DD18CRD/4P-SCT
Voltage	220-240Vac 50/60Hz	220-240Vac 50/60Hz
Current (mA)	62	91
Rated Power (W)	12	18
Power Factor	0.84	0.86
Luminous Flux (lm)	1430 (2700k) 1480 (4000k) 1430 (6500k)	2100 (2700k) 2200 (4000k) 2100 (6500k)
Nominal Lifetime (h)	30000	30000
Lifetime (L70B50) (h)	54000	54000
Lifetime (L80) (h)	54000	54000
Lifetime (L90) (h)	42000	42000
Blue Light Hazard	RG1	RG1
Glow Wire Temperature (°C)	650	650
Dimensions (LxWxD) (mm)	38 x 192ø	38 x 192ø
Weight (Kg)	0.2	0.2
Lighting Technology used	LED	LED
Directional / Non-Directional	NDLS	NDLS
Cap Type / interface	GR10q	GR10q
Mains / Non-Mains	MLS	MLS
Connected Light Source	No	No
Colour Tuneable Lightsource	No	No
High luminance light source	No	No
Anti-glare shield	No	No
Dimmable	No	No
CCT	2700k Warm White 4000k Cool White 6500k Day Light	2700k Warm White 4000k Cool White 6500k Day Light
Energy Consumption in on-mode (kWh/1000h)	12	18
Energy Efficiency Class	E	E
Useful Luminous Flux (lm)	1430 (2700k) 1480 (4000k) 1430 (6500k)	2100 (2700k) 2200 (4000k) 2100 (6500k)
Beam Angle Correspondence (°)	360	360
On-mode power (Pon) (W)	12	18
Standby power (Psb) (W)	0.5	0.5
Networked standby pwr (CLS) (Pnet)	N/A	N/A
CRI	82	82
Claim of equivalent power	No	No
Equivalent power	N/A	N/A
Chromaticity Coordinates	0.463(x), 0.416(y) (2700k) 0.377(x), 0.367(y) (4000k) 0.308(x), 0.330(y) (6500k)	0.463(x), 0.416(y) (2700k) 0.386(x), 0.373(y) (4000k) 0.308(x), 0.330(y) (6500k)
Peak luminous intensity (DLS) (cd)	N/A	N/A
Beam angle (DLS) (°)	N/A	N/A
R9 CRI value (LED/OLED)	10 (2700k) 33 (4000k) 12 (6500k)	9 (2700k) 32 (4000k) 11 (6500k)
Survival Factor	0.9	0.9
Lumen maintenance factor	0.96	0.96
Displacement factor (Mains LED/OLED)	0.94	0.94
Colour consistency in mcdam ellipses (Mains LED/OLED)	6	6
LED light source rep. a fluorescent light source without integrated ballast of a particular wattage (Mains LED/OLED)	No	No
Rep. W claim (Mains LED/OLED)	N/A	N/A
Flicker (pst LM) (Mains LED/OLED)	0.1	0.1

Stroboscopic effect metric (SVM)	0.1	0.1
Ambient Temperature (°C)	-20 to 40	-20 to 40
Emergency Module	EMDD02 (standard) CEC02LBL/S (self-test)	EMDD02 (standard) CEC02LBL/S (self-test)
Emergency Luminous Flux (lm)	180	180

Sensor Specification

Sensor Type	Microwave	Microwave	Microwave
Detection Range (m)	1-8	1-8	1-8
Detection Angle (°)	360	360	360
Operation Time	8sec-30min	8sec-30min	8sec-30min
Ambient Light Threshold (lux)	10-2000	10-2000	10-2000
Standby Power (W)	1.2	1.2	1.2
HF System	5.8GHz	5.8GHz	5.8GHz
Sensor Output (mW)	<0.2	<0.2	<0.2

Dimensions

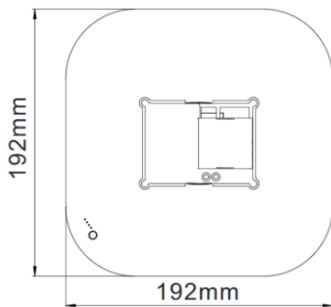
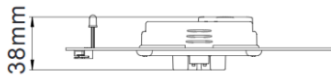

Photometric Information

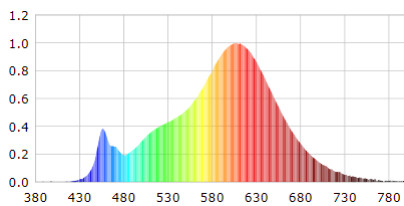

12W-2700k

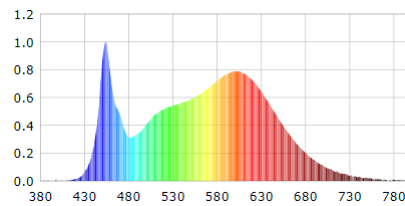

12W-4000k

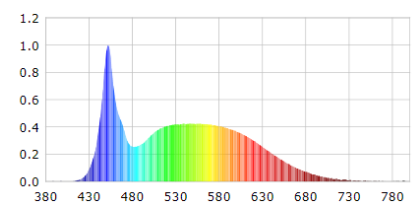

12W-6500k

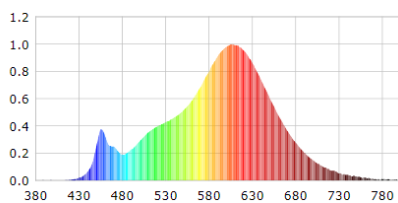

18W-2700k

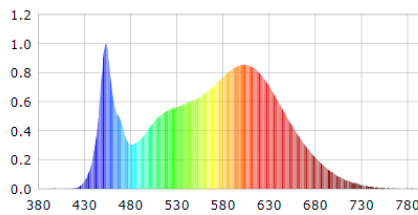

18W-4000k

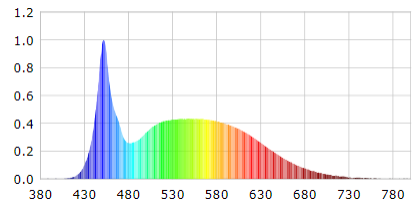

18W-6500k

Fitting Conversion

The existing fitting must be switched off and isolated at the mains before commencing electrical work. It is the responsibility of the converter to ensure the fitting continues to meet safety requirements. If in doubt consult a qualified electrician. For maximum energy savings, bypass all control gear and wire from the mains to the lampholder as for an electronic high frequency ballast conversion.

Magnetic Ballast (Choke):

- Remove the starter and any power factor capacitor. The capacitor may be left in place but the energy savings will be less.
- Plug the LED DD lamp directly into the lampholder.

Electronic Ballast (High Frequency) Conversion:

- The electronic ballast is not required so it must be removed or bypassed.
- Wire the Live and Neutral directly from the supply to the lampholder terminals as per below.
- The Live and Neutral must be wired to opposite terminals on the lampholder and not be wired to terminals on the same side.
- A 1A fuse may be added between the Live supply and the lampholder to prevent the circuit from cutting-out in the event of a fault in a single luminaire.

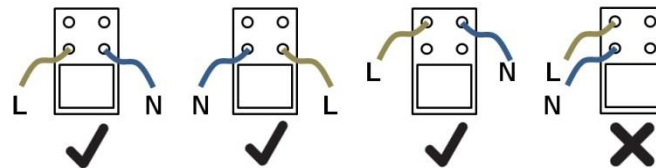

Add an indelible warning label, visible when changing the lamp, showing the substance of:

Warning - not for use with fluorescent lamp, use only Kosnic LED DD lamp.

Optional Emergency Module

An optional emergency module for the LED DD lamp can be installed within the fitting to provide a back-up supply in the event of a power cut. The emergency module requires a permanent live un-switched supply to maintain the battery charge. In the event of a power cut the battery within the emergency module will supply the LED DD lamp at a reduced voltage through the supplementary socket provided for this purpose. The supplementary socket also connects the emergency module to the green charging indicator on the LED DD lamp.

